

Motor Racing Signalling System

The system is based on the realization of signal light and departure light controlling to expand the flag function. It uses high brightness LED components to achieve the maximum visual angle and high brightness display. The system uses the network architecture of TCP/IP protocol to facilitate future expansion.

1. System Chart

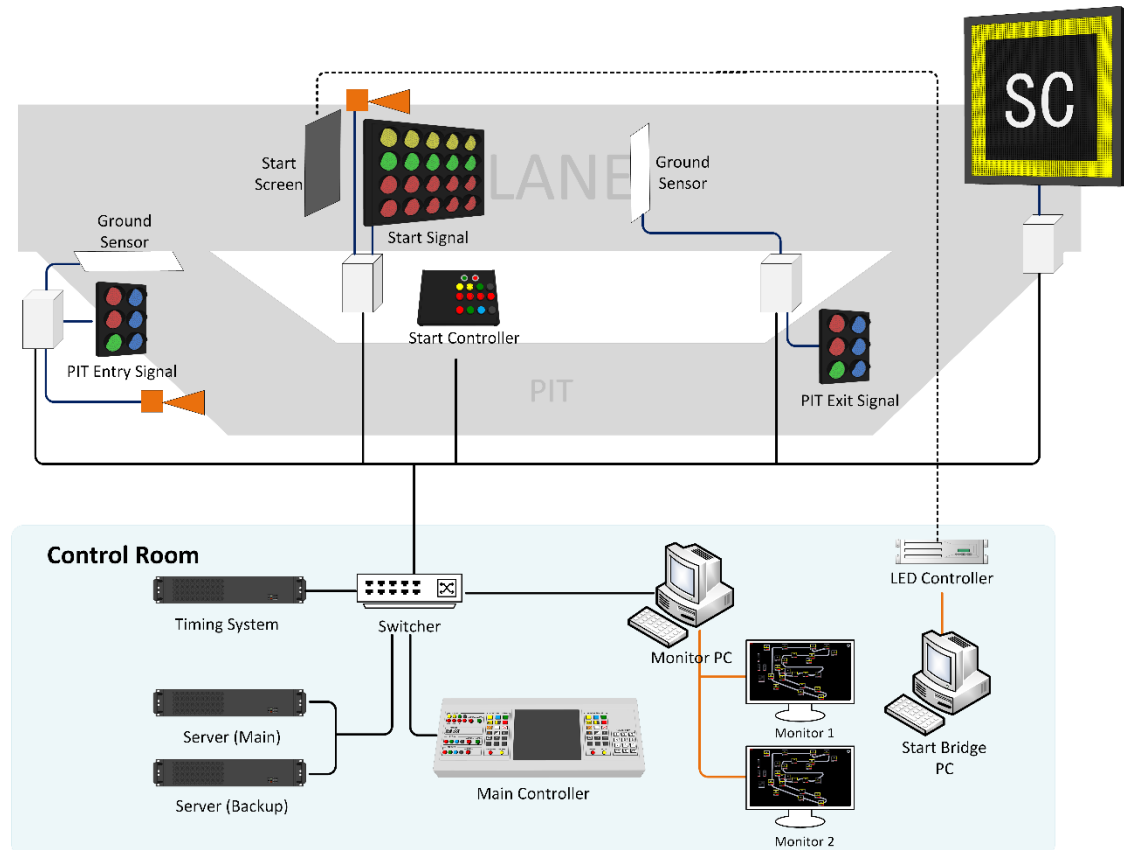

System structure description

(1) All signal lights are centrally controlled by the command center, so as to avoid flag leakage and mistake by the referee in the event. The system architecture gets rid of the complex mode of PLC BUS, builds a new fiber ring installation network system, and controls the front-end signal light screen and the start bridge signal light screen through the TCP/IP protocol. The working state of the front-end equipment can be detected through the network.

(2) The system uses a ring fiber in the loop, any direction loop failure will not affect the normal operation of the whole system. When a single machine failure occurs in the main controller, it will not affect the normal operation of the whole system.

2. Specification for products

2.1 Server

All info of the system is summarized and controlled by the server installed in the control room.

Cabinet: 2U

In order to ensure the safe and stable operation of the system, one main server and one standby server are set up.

2.2 Main Controller

Product	Specification
Main Controller	<p>Type: KS-MRSG-MCTL Size: 930x380x100 (mm) Weight: 10 KG Display: Full color touch LCD (15Inch) Communication: Ethernet Functions:</p> <ul style="list-style-type: none"> ◆ Semaphore signal control: include "independent signal" and "all signal". Overall control of all the lane screens or separate control of a separate lane screen. Display the specified car number on the lane screen. ◆ Start signal control: static start, rolling start and other start operations. ◆ Terminal signal control: control to display checkered flag on the terminal screen. ◆ Control the entrance signal of PIT. ◆ Control the exit signal of PIT.

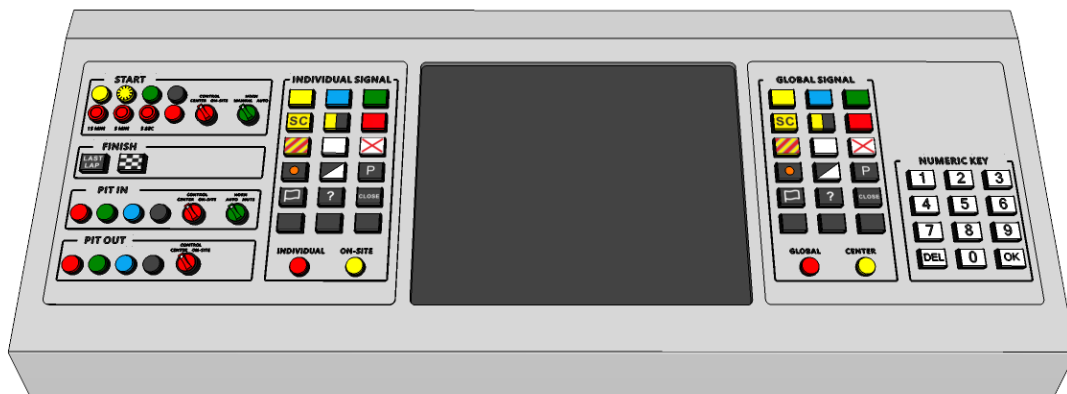

2.3 Portable controller

Product	Specification
Portable controller	<p>Type: KS-MRSG-PCTL Size: 410x330x180 (mm) Weight: 4.6 KG Display: Full color LCD (7 Inch) Communication: Ethernet Functions:</p> <ul style="list-style-type: none">◆ Includes all functions of the "main controller", and can be enabled in main controller fails or other cases needs to operate the system in a temporary location.



2.4 Monitor screen

2.5 Starting bridge display

Display control PC

Installed in the control room and connected with the timing system to obtain real-time info.

Run CMS system on the PC to display videos and ADs.

At the same time, run the timing software to display the timing time in the lower right corner of the screen.

2.6 Starting bridge equipment

Controller

Installed in the electric box in the departure area.

Receive the signal of control room through network, control the signal of starting signal light and the sound of siren.

2.7 Starting signal light

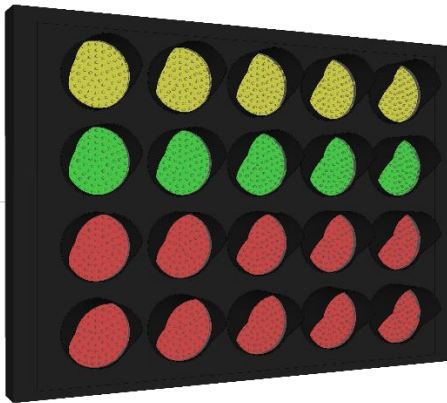

Specification: traffic light F300MM

Size: ≤ 2000mm

The red light is lit from right to left one by one in the process of starting. And the lighting interval varies according to the countdown mode (15 minutes, 5 minutes, 5 seconds) selected by the users.

2.8 Start controller

Installed in the control post booth in the departure area and only be used when the control center delegated power to the "local".

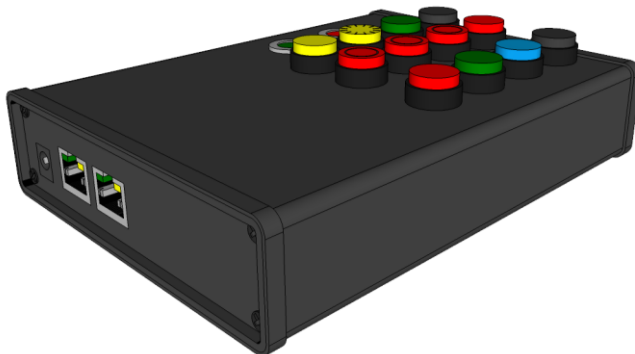

2.9 PIT entry equipment

(1) PIT entry controller

Installed in the electronic box of at the entry of PIT.

Detect ground sense of the cars, and auto control the buzzer to generate a siren sound when a car passes by.

Access to the network, receive the network signal from the control room, control the entry signal at the entry of PIT, and return the current working state.

(2) PIT entry signal

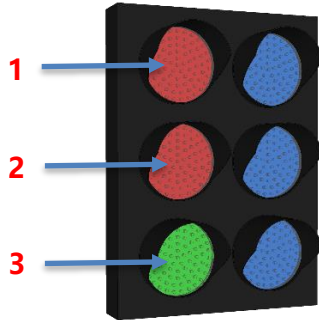

Specification: traffic light F300MM

Lights 1, 2 and 3 are manually controlled from the control room or "start controller" at the starting point.

2.10 PIT exit equipment

(1) PIT exit controller

Installed in the electronic box of at the exit of PIT.

Detect ground sense of the cars, and auto control the signal light to flash blue when a car passes by.

Access to the network, receive the network signal from the control room, control the signal light at the exit of PIT, and return the current working state.

(2) PIT exit signal

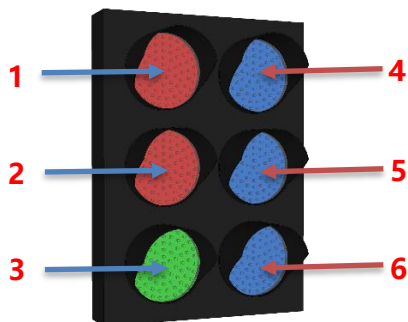

Specification: traffic light F300MM

Lights 1, 2 and 3 are manually controlled from the control room or "start controller" at the starting point.

Blue lights 4, 5 and 6 not only support manual controlled, but also support auto flashing (3 flashes per second for 3s) when the ground sensor detects a car passing by.

2.11 Lane screen

Product	Specification
Lane screen	<p>Type: KS-MRSG-LSCN Size: 1000x1000x120 (mm) Weight: 40KG Material: Aluminum Functions:</p> <ul style="list-style-type: none">◆ Display variants of flag: Green, Red, Yellow, SC, etc.◆ Display the chess flag.◆ Feedback the real-time running status automatically.

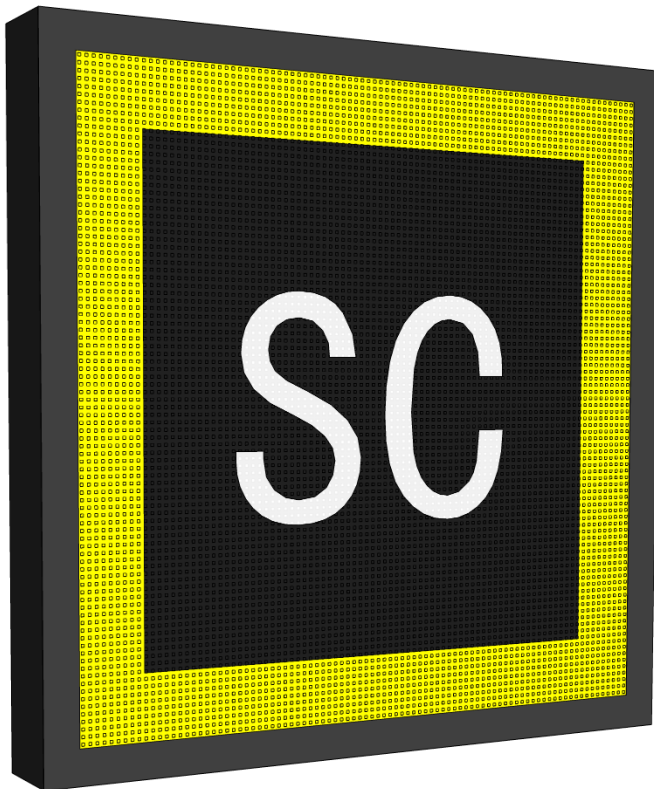

2.12 Lane screen controller

Product	Specification
Lane screen controller	<p>Type: KS-MRSG-LCTL Size: 240x190x110 (mm) Weight: 1.2 KG Functions:</p> <ul style="list-style-type: none">◆ Installed next to the column of the lane screen to receive the control instructions sent by the control room, and send the instructions to the LED control card. At the same time, it will send back working status regularly.◆ Control the lane screen independently.◆ Able to input the car number.

